



OPERABLE PARTITIONS

700 SERIES

700 SERIES



700 SERIES

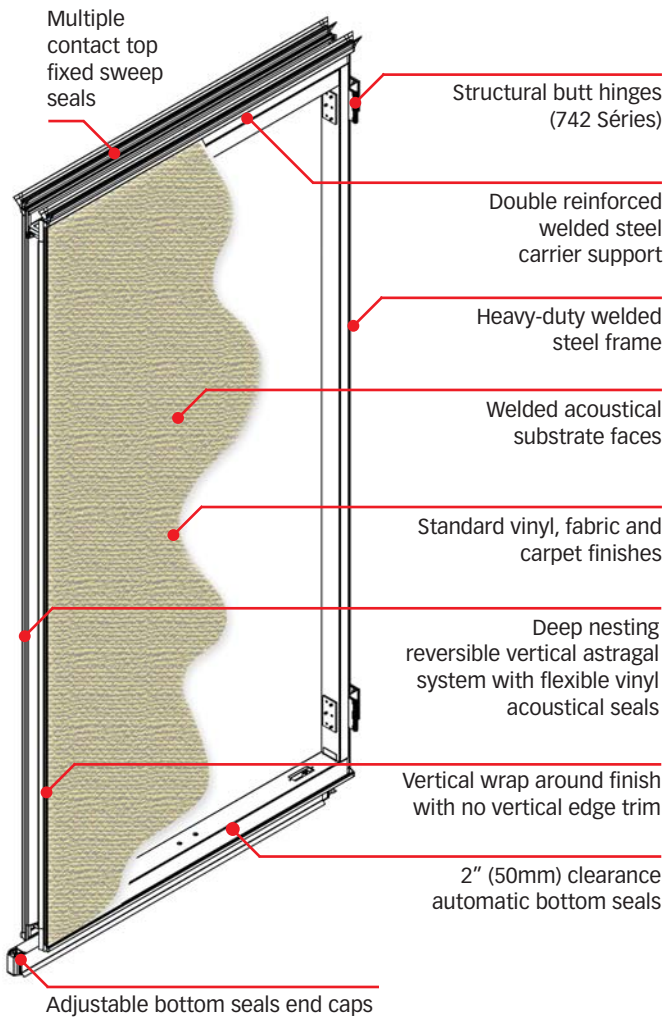

↑ Vertical wrap around finish with no vertical edge trim

Features



The Moderco 700 series offers a technologically advanced, aesthetically pleasing design. It uses a unique welded steel frame that permits all substrates (skins), both tackable and steel to be welded to the frame. It never requires substrates or skins to be glued or mechanically attached to the frame. This construction provides a durable, unitized panel that will last for years of rugged use.

The basic panel construction is combined with wraparound finishes for a trimless, monolithic appearance. Deep interlocking vertical astragals at all panel joints align panels ensuring a smooth wall face while providing an acoustic seal.

Automatically setting and retracting bottom seals provide 2 inches of operating clearance to accommodate for floor variation.

This combination of features together with the 700 series options and many varied finishes make it an outstanding choice for your applications as it combines aesthetics, acoustics, and durability in one construction.





Available Features:

The Moderco 700 SERIES product offers numerous options including marker boards, marker/chalk trays, eraser pockets, same construction pass thru doors and inset exit signs. Consult with your local Moderco distributor or visit www.moderco.com for more details.

PASS DOOR FEATURES

The 700 SERIES pass door system from Moderco has a host of features and options:

- Heavy-duty welded laser-cut steel panel and door framing systems
- ADA compliant push-pull door hardware
- Aluminum-reinforced protective door edge trim for durability and identification
- Face-activated bottom seals with stabilizing downward force
- Field-adjustable bottom seals on door leaf
- Complete panic bar hardware (available upgrade)
- Concealed automatic door closer (available upgrade)
- Inset exit sign (available upgrade)
- Door viewer (available upgrade)
- Door window (available upgrade)
- Key lock on both standard or panic bar hardware (available upgrade)

ALUMINUM TRACK SYSTEMS

Moderco tracks available with the 700 SERIES are of clear anodized extruded architectural grade alloy. Moderco aluminum tracks feature quiet operation, consistent shape for end-to-end alignment, selection of 3 ceiling soffits, corrosion resistance and hard running surface for proper carrier movement. Moderco tracks have been tested for a minimum of 10 years of use.

The 700 SERIES uses #33 track and trolleys on the 741 SERIES individual panels system and #45 track and trolleys on the 742 SERIES paired panels system.

CUSTOM-BUILT POCKET DOORS

Moderco offers with the 700 SERIES a complete range of acoustical and non-acoustical custom built pocket doors. These pocket doors consist of either one, two or even three sections and are designed for your specific utilisation.

WARRANTY

Moderco 700 SERIES products are guaranteed against defects in material and workmanship for two years. Aluminum track and trolleys systems are guaranteed for an extended period of five years. Compare our warranty with others available in the industry.

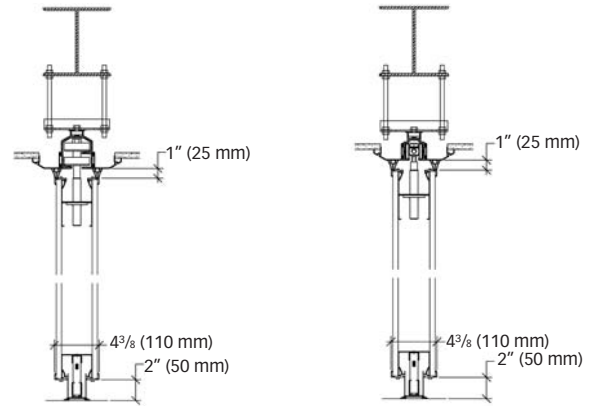

741 SERIES

742 SERIES

700 SERIES VERTICAL SECTIONS

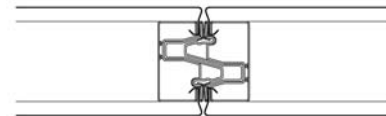

741 SERIES

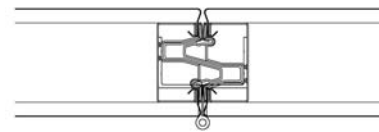

742 SERIES

700 SERIES HORIZONTAL SECTIONS

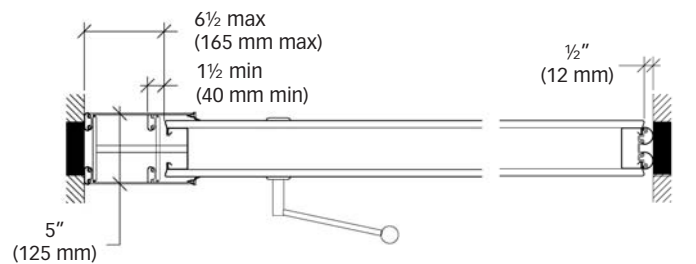

TELESCOPE CLOSURE

BULB SEAL

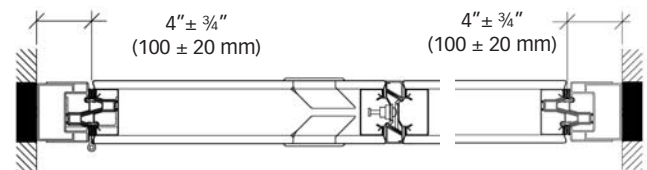

HINGED CLOSURE

WALL JAMB

END PANEL CLOSURES SECTIONS

700 SERIES

700 SERIES PRODUCT GUIDE

MODEL	STACK	CONFIGURATION	OPERATION	STC RATING	PANEL HANGING WEIGHT Lbs/sq. ft. (Kg/m ²)	MAX. HEIGHT	MAX. WIDTH
741	Side	Single	Manual	43 / 48 / 50 / 54	5.5 @ 9.2 (27 @ 45)	16'-3" (4,95m)	Unlimited
741	Remote	Single	Manual	43 / 48 / 50 / 54	5.5 @ 9.2 (27 @ 45)	16'-3" (4,95m)	Unlimited
742	Center	Pairs	Manual	43 / 48 / 50 / 54	5.5 @ 9.2 (27 @ 45)	16'-3" (4,95m)	Unlimited

(PRODUCT GUIDE CONTINUED)

MODEL	TOP FIXED SWEEPS	AUTOMATIC BOTTOM SEALS	VERTICAL EDGE	THICKNESS	FINISHES
741	Std	Std	Trimless	4" (100mm)	Vinyl / Fabric / Carpet
741	Std	Std	Trimless	4" (100mm)	Vinyl / Fabric / Carpet
742	Std	Std	Trimless	4" (100mm)	Vinyl / Fabric / Carpet

STACK MODES

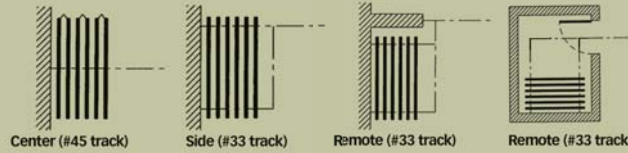

■ MATERIALS

A. Product to be top supported model [741 individual panels or 742 paired panels] as manufactured by Moderco inc.

1. Panels shall be nominally 4" [100mm] thick, in manufacturer's standard widths up to 48" [1230mm].
2. Panel faces shall be made of appropriate acoustical substrate to meet the STC requirement. Panel faces shall be welded to the internal steel frame. Panel faces shall be formed to protect the panel edges.
3. Frames shall be made of steel, they should be welded. No vertical face trim shall be allowed.
4. Interlocking vertical seals between the panels shall consist of tongue and groove aluminum and vinyl reversible astragals creating a shock-absorbing, deep nesting, impact resistant acoustical interlock between panels.
5. Horizontal top seals shall be continuous contact multi-fingered vinyl.
6. Horizontal bottom seals shall automatically operate as the panels are positioned, providing 2" [50mm] nominal operating clearance, and exert downward force when extended. Crank type seals shall not be acceptable.

B. Weight of the panels shall be between 5.5 and 9.2 lbs./sq. ft. [27,0 and 45,0 kg/sq.m] based on Options selected.

C. Suspension system

1. Track shall be clear anodized tempered aluminum with soffit trim of clear anodized aluminum providing a transition to the ceiling. Track shall include support brackets and hanger rods, spaced to manufacturer's standards.
(Select one) **741**
 - Each panel shall be supported by two dual horizontal wheel trolley assemblies made of glass-reinforced, self lubricating nylon with steel precision ground bearings. Carrier design shall use a counter rotating concept to move panels along the track and through 90 degree "L", "T", & "X" intersections. Carriers using friction discs shall not be permitted.
- or **742**
 - Each panel shall be supported by one 4-wheeled carrier. Wheels to be of hardened steel ball bearings encased with nylon tires. Carrier design shall ensure that all wheels remain in contact with the track during normal movement of the panels.]

D. Finishes

1. Face finish shall be: (select as required):
 - a. Factory applied reinforced vinyl wall-covering with woven backing, weighing 20 oz. or more per lineal yard [465 g/m]. Color shall be selected from manufacturer's standard color selector.

b. Standard up-grade finishes (color shall be selected from manufacturer's standard color selector):

- (1) Factory applied vertical ribbed carpet (N.R.C. .20)
- (2) Factory applied 100% polyolefin stain resistant fabric
2. Frame color shall be standard dark.
3. Aluminum track and soffit shall be clear anodized

E. Accessories/Options

1. ADA-compliant pass door of the same thickness, construction and finish as the basic panels.
2. Inset dry marker boards. Location and height as indicated on plans.
3. Inset porcelain marker boards. Location and height as indicated on plans.
4. Inset chalk boards. Location and height as indicated on plans.
5. Inset tack boards. Location and height as indicated on plans
6. Acoustical Pocket doors.

■ OPERATION

A. Panels shall be manually operated, top supported, moved [741 individually or 742 in pairs] from the storage area, positioned in the opening, and seals set.

B. Automatic Bottom Seals

1. Bottom seals shall automatically activate as panels are deployed / positioned without the use of any handle or action by the operator and shall automatically retract when panels are moved to be stored.

C. Final partition closure

1. Telescopic closure panel incorporating an expanding jamb member operated from either side of the panel with a removable handle. Panel shall be capable of compensating for minor out-of-plumb wall conditions and provide a positive vertical seal between partition and building structure.
or
1. Available under 12'-3" [3730 mm]: Hinged Closure Panel permanently attached to the structural wall. Panel permits access between adjacent rooms and shall be of the same finish as basic panels. Top and bottom seals shall be continuous contact multi-ply vinyl. Hardware shall be recessed.

■ ACOUSTICAL PERFORMANCE

A. Acoustical performance shall have been tested at an NIST and NVLAP-accredited, independent laboratory in accordance with ASTM E90-04 or more recent Test Standards. Standard panel construction shall have obtained a minimum STC rating of (select one): [43, 48, 50 or 54].



MODERCO

For additional information:

www.moderco.com
info@moderco.com

More than 130 distributors Worldwide.
Free brochures,
Architectural binders and technical data sheets.

Moderco Inc.

115 de Lauzon,
Boucherville,
(Québec) J4B1E7
Phone: 1-800-363-3150
Fax: 1-800-231-4965



Printed on recycled paper

All informations contained in this brochure are subject to change without notice